



L'EXPERT DE L'IRRIGATION CONNECTÉE



BL-AG

PROGRAMMATEUR
D'IRRIGATION AGRICOLE



**GUIDE
D'INSTALLATION
RAPIDE**

FR p.01-05
EN p.06-10
ES p.11-15
IT p.16-20

PRÉSENTATION

Le **BL-AG** est un programmeur d'irrigation agricole conçu pour les professionnels souhaitant irriguer leurs parcelles de manière simple et connectée. Ses fonctionnalités répondent parfaitement aux besoins spécifiques des professionnels de l'agriculture.

Étape 1

TÉLÉCHARGEMENT

1. Sur votre smartphone et/ou tablette, rendez-vous sur l'application «**App Store**» ou «**Google Play**».



2. Recherchez «**MySOLEM**» dans la barre de recherche.

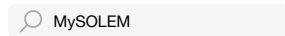

3. Une fois trouvée, téléchargez l'application **MySOLEM**.



OBTENIR

INSTALLER

4. Une fois installée, activez le Bluetooth® de votre smartphone et/ou tablette.

Étape 2

ASSOCIATION

1. Dévissez le bouchon du **BL-AG**.
2. Branchez une **pile 9V Alcaline** et revissez le bouchon.
3. Lancez l'application **MySOLEM** depuis votre smartphone et/ou tablette.
4. Appuyez sur le bouton «**Ajouter un programmeur**» ou sur le bouton «**+**».
5. Choisissez le **BL-AG** parmi la liste des programmeurs disponibles à proximité.
6. Suivez les étapes décrites sur l'application pour terminer l'association de votre **BL-AG**.



INSTALLATION

1. Raccordez votre **BL-AG** aux électrovannes comme illustré ci-dessous. Utilisez des électrovannes avec **solénoïdes 9V à impulsion**.

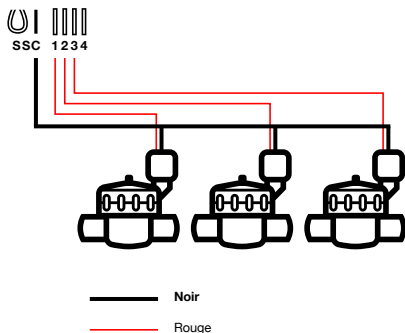

2. (Optionnel) Si vous souhaitez installer une sonde de pluie, coupez le **fil jaune** pour la raccorder à votre **BL-AG**.

PROGRAMMATION

Pour tout renseignement supplémentaire sur le **BL-AG** et l'application **MySOLEM**, connectez-vous à www.solem.fr et consultez ou téléchargez notre documentation complémentaire.

INFORMATIONS UTILES

Quelles sont les caractéristiques requises pour que le produit Bluetooth® fonctionne ? Téléphones et tablettes Android 4.3 et supérieur équipés du Bluetooth Smart 4.0 et supérieur. Apple iPhone ou iPad avec iOS 9.0 et supérieur équipés du Bluetooth Smart 4.0 et supérieur.

A quoi servent les sorties S (Fil jaune) du programmeur ? Vous pouvez brancher une sonde de pluie sur les sorties S pour cela il vous faut couper le fil jaune.

Comment puis je reprendre la procédure d'association ou d'initialisation à zéro ? Pour reprendre une procédure d'initialisation, il suffit de court-circuiter les 2 plots de la pression pile (enlever la pile préalablement) pendant 30s minimum.

Si mon appareil n'a plus de pile, est-ce que je perds les programmes ? Non, ils ne sont jamais perdus, ils sont sauvegardés dans une mémoire.

Je voudrais réinitialiser la programmation de mon appareil, comment faire ? Ouvrez l'application, entrez dans le produit puis ouvrez les  **Paramètres** et sélectionner «**Effacer les programmes et durées**».



THE CONNECTED IRRIGATION EXPERT



BL-AG

AGRICULTURAL IRRIGATION CONTROLLER



QUICK
INSTALLATION
GUIDE

INTRODUCTION

The **BL-AG** is an agricultural irrigation controller designed for professionals. It's the perfect solution for a simple and a smart irrigation of plots. Its features are made to answer agricultural needs.

Step 1

APP DOWNLOAD

1. On your smartphone or tablet, go to the «**App Store**» or to the «**Play Store**» app.



2. Search for «**MySOLEM**» in the search bar.

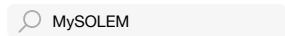

3. Once found, download the **MySOLEM** app.



4. Once installed, activate the Bluetooth® of your smartphone or tablet.

Step 2

PAIRING

1. Unscrew the **BL-AG**'s cap.
2. Plug the **9V Alkaline battery** and screw the cap.
3. Launch the **MySOLEM** app.
4. Tap on the «**Add a module**» button or on the «**+**» button.
5. Choose the **BL-AG** from the list of nearby controllers.
6. To finish the pairing of your **BL-AG**, follow the next steps described in the app.



Step 3

WIRING

1. Connect the **BL-AG** to the solenoids as described below. Use **9V pulse** valves only.

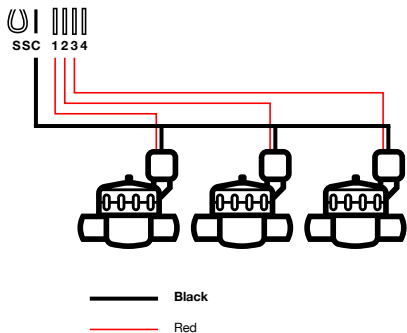

2. (Option) If you want to install a rain sensor, cut the **yellow wire** of the **BL-AG** and connect it to the sensor.

PROGRAMMING

If you need more information about the **BL-AG** and **MySOLEM** app, please visit our website www.solem.fr and check our supplementary documentation.

USEFUL INFORMATION

What are the features required for the Bluetooth® product to work?

Smartphone or tablet running Android 4.3 or greater with Bluetooth Smart 4.0 or greater. Apple iPhone or iPad running iOS 9.0 or greater with Bluetooth Smart 4.0 or greater.

What are the S outputs (Yellow Wires) of the programmer? You can connect a Rain Sensor on the **S** outputs by remove the Yellow wire.

How can I restart the initialization procedure (for example : change the router acces point) ? To reset a device or restart an initialization procedure, short circuit the 2 pads of the battery pressure (remove the 9V battery previously) for 30s minimum.

If my device does not have a battery, do I lose programs? Programs are never lost, they are saved in a memory.

I would like to resume the programming from the beginning, how to do? If you want to resume programming, go to the application, enter the product and then open the  **Parameters** and select «**Clear programs and durations**».



EL EXPERTO DEL RIEGO CONECTADO



BL-AG

PROGRAMADOR DE RIEGO AGRÍCOLA



GUÍA
RÁPIDA DE
INSTALACIÓN

INTRODUCCIÓN

El **BL-AG** es un programador de riego agrícola diseñado para profesionales que desean regar sus parcelas de una forma simple y conectada. Sus prestaciones responden perfectamente a las necesidades específicas de los profesionales de la agricultura.

Paso 1

DESCARGA

1. En su smartphone y/o tableta, vaya a la aplicación «**App Store**» o «**Play Store**».



2. Encuentre «**MySOLEM**» en la barra de búsqueda.

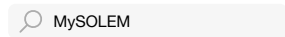

3. Una vez localizada, descargue la aplicación **MySOLEM**.



OBTENER

INSTALAR

4. Una vez instalada, active su Bluetooth® en su smartphone o tableta.

ASOCIACIÓN

1. Desenrosque el tapón del **BL-AG**.
2. Conecte la **pila alcalina de 9V** y rosque el tapon.
3. Inicie la aplicación **MySOLEM** desde su smartphone y/o tableta.
4. Pulse en «**Añadir un módulo**» o sobre el botón «+».
5. Escoja el **BL-AG** entre la lista de programadores disponibles y cercanos.
6. Siga los pasos siguientes, descritos en la aplicación, para finalizar la asociación de su **BL-AG**.



INSTALACIÓN

1. Conecte su **BL-AG** a las electroválvulas como se muestra abajo. Utilice electroválvulas con **solenoides de impulsos de 9V**.

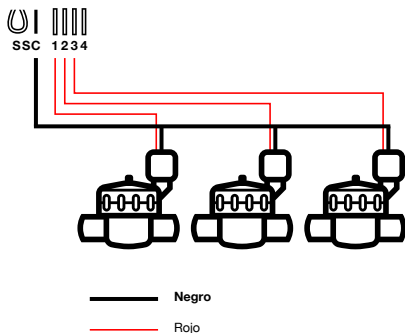

2. (Opción) Si desea instalar una sonda de lluvia, corte el **cable amarillo** para conectarla a su **BL-AG**.

PROGRAMACIÓN

Si ud necesita más información sobre el **BL-AG** y la aplicación **MySOLEM**, conéctese a la página web **www.solem.fr** y formule la consulta o descárguese nuestra documentación complementaria.

INFORMACIÓN ÚTIL

¿Cuáles son las características requeridas para el funcionamiento del producto Bluetooth®? Smartphone o tableta Android 4.3 y superior equipada de Bluetooth Smart 4.0 y superior. Apple iPhone o iPad con iOS 9.0 y superior equipada de Bluetooth Smart 4.0 y superior.

¿Cuáles son las salidas S (Cable Amarillo) del programador? Se puede conectar un sensor de lluvia en las salidas S. Para ello, tiene que quitar el cable amarillo.

¿Cómo se puede repetir el procedimiento de inicialización (Por ejemplo, cambiar el punto de acceso al router)? Para resetear un dispositivo o repetir el procedimiento de inicialización, provoque un corto-circuito, uniendo los dos bornes del conector de la batería (previamente quite la pila) durante un mínimo de 30s.

¿Si mi dispositivo no tiene batería, perderé los programas? Los programas nunca se pierden, , se guardan en una memoria.

¿Me gustaría retomar la programación de mi dispositivo desde el principio, cómo hacerlo? Si Ud. quiere retomar la programación, abra la aplicación, seleccione el producto, abra los  **Parámetros** y seleccione «**Borrar programas y horarios**».



L'ESPERTO DI IRRIGAZIONE COLLEGATO



BL-AG

PROGRAMMATORE DI
IRRIGAZIONE AGRICOLO



GUIDA
RAPIDA PER
L'INSTALLAZIONE

INTRODUZIONE

Il **BL-AG** è un programmatore per l'irrigazione professionale specifico per il settore agricoltura. E' la soluzione perfetta per una irrigazione semplice ed intelligente. Le sue caratteristiche rispondono perfettamente alle necessità del settore agricoltura.

Passo 1

SCARICAMENTO

1. Dal tuo smartphone o tablet accedi ad «**App Store**» o «**Play Store**».



2. Cerca «**MySOLEM**».

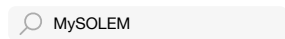

3. Scarica l'Applicazione **MySOLEM**.



↓ SCARICA

INSTALLA

4. Una volta installato, attiva il Bluetooth® sul tuo smartphone o tablet.

ASSOCIAZIONE

1. Svita il coperchio del **BL-AG**.
2. Inserisci una **batteria alcalina da 9V** e riavvitare il tappo.
3. Avvia L'applicazione **MySOLEM**.
4. Premi il tasto «+» o «aggiungi un modulo».
5. Tocca l'immagine del **BL-AG** e selezionalo dalla lista di quelli disponibili nelle vicinanze.
6. Segui le indicazioni richieste dalla App in modo da terminare l'associazione del tuo **BL-AG**.



INSTALLAZIONE

1. Connetti il tuo **BL-AG** al solenoide bistabile come mostrato in figura. Utilizza solo **solenoidi bistabili 9V**.

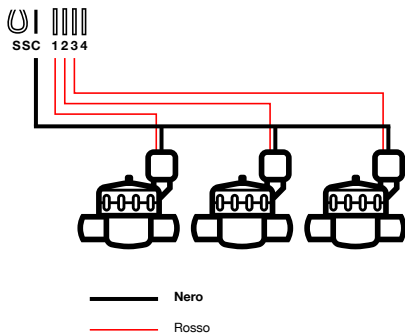

2. (Opzionale) Per utilizzare un sensore pioggia, tagliare il **filo giallo** per collegarlo al vostro **BL-AG**.

PROGRAMMAZIONE

Per maggiori informazioni riguardo il **BL-AG** e l'applicazione **MySOLEM**, scaricare dal sito web **www.solem.fr** la nostra documentazione completa.

INFORMAZIONI UTILI

Quali sono i requisiti necessari per il funzionamento del prodotto Bluetooth®? Smartphone o tablet Android 4.3 y superiore dotato di Bluetooth Smart 4.0 y superiore. Apple iPhone o iPad con iOS 9.0 y superiore dotato di Bluetooth Smart 4.0 y superiore.

programmatore? Puoi connettere un sensore pioggia alle uscite **S** togliendo il cavo giallo e collegando i cavi del sensore pioggia.

Come posso riavviare il procedimento di inizializzazione? Per riavviare una procedura di inizializzazione, è sufficiente staccare la pila e fatto un corto circuito (con un cacciavite) sulla pressione pila di prodotto WF-IP per 30 secondi minimo e ricollegarlo.

Se il mio dispositivo ha la batteria scarica perde la programmazione impostata? I programmi non si perdono mai, essi vengono salvati in memoria.

Vorrei riportare la programmazione del mio programmatore alle impostazioni di fabbrica, come fare? Accedi alla APP **MySOLEM** sul tuo smartphone o tablet; scegli il prodotto che vuoi riportare ai valori impostati in fabbrica, accedi al menù  **Parametri** e seleziona «**Cancella i programmi e le durate**».